

## AA and AB-Series Analog Sensors

NVE’s AA and AB-Series analog GMR sensors offer unique and unparalleled magnetic sensing capabilities. These sensors are characterized by high sensitivity to applied magnetic fields, excellent temperature stability, low power consumption, and small size. These characteristics make them suitable for use in a wide variety of applications from rugged industrial and automotive position, speed, and current sensors, to low-voltage, battery-powered sensors for use in hand-held instrumentation and implantable medical devices. The unmatched versatility of these basic magnetic sensors makes them an excellent choice for a wide range of analog sensing applications.

The AA-Series sensors use NVE’s patented GMR materials and on-chip flux concentrators to provide a directionally sensitive output signal. These sensors are sensitive in one direction in the plane of the IC, with a cosine-scaled falloff in sensitivity as the sensor is rotated away from the sensitive direction. Also, these devices provide the same output for magnetic fields in the positive or negative direction along the axis of sensitivity (omnipolar output). All sensors are designed in a Wheatstone bridge configuration to provide temperature compensation. Two packages are offered, an SOIC8 and an MSOP8. These sensors are also available in die form on a special-order basis.

There are three families of NVE’s basic AA-Series sensors: the standard AA-Series, the AAH-Series, and the AAL-Series. Each of these sensor families uses a different GMR material, with its own characteristics. The comparison table below summarizes the different characteristics of the GMR materials:

Parameter	AA Series	AAH Series	AAL Series
Sensitivity to Applied Fields	High	Very High	High
Field Range of Operation	High	Low	Medium
Hysteresis	Medium	High	Low
Temperature Range	High	Very High	Very High

The AB-Series sensors are differential sensor devices, or gradiometers, which take advantage of the high output characteristics of NVE’s GMR materials. Two families of AB sensors are offered, the standard AB-Series and the ABH-Series. They have operational characteristics similar to the AA and AAH sensors described in the table above but with the bipolar linear output characteristics of a differential sensor.

Within these different sensor families, customers can find an excellent match to their analog sensor requirements.

## Quick Reference: AA and AB-Series

For comparison and product selection purposes, the following table lists all available AA and AB-Series analog sensors, with some of their key characteristics:

### Magnetometers:

Part Number	Linear Range (Oe <sup>1</sup> )		Sensitivity (mV/V-Oe <sup>1</sup> )		Maximum Non-linearity (% Uni. <sup>2</sup> )	Maximum Hysteresis (% Uni. <sup>2</sup> )	Maximum Operating Temp (°C)	Typical Resistance (Ohms)	Package
	Min	Max	Min	Max					
AA002-02	1.5	10.5	3.0	4.2	2	4	125	5K	SOIC8
AA003-02	2.0	14	2	3.2	2	4	125	5K	SOIC8
AA004-00	5.0	35	0.9	1.3	2	4	125	5K	MSOP8
AA004-02	5.0	35	0.9	1.3	2	4	125	5K	SOIC8
AA005-02	10.0	70	0.45	0.65	2	4	125	5K	SOIC8
AA006-00	5.0	35	0.9	1.3	2	4	125	30K	MSOP8
AA006-02	5.0	35	0.9	1.3	2	4	125	30K	SOIC8
AAH002-02	0.6	3.0	11.0	18.0	6	15	150	2K	SOIC8
AAH004-00	1.5	7.5	3.2	4.8	4	15	150	2K	MSOP8
AAL002-02	1.5	10.5	3.0	4.2	2	2	150	5.5K	SOIC8

### Gradiometers:

Part Number	Linear Range (Oe <sup>1</sup> )		Resistor Spacing (mm)	Maximum Non-linearity (% Uni. <sup>2</sup> )	Maximum Hysteresis (% Uni. <sup>2</sup> )	Maximum Operating Temp (°C)	Typical Resistance (Ohms)	Package
	Min	Max						
AB001-02	20	200	0.5	2	4	125	2.5K	SOIC8
AB001-00	20	200	0.5	2	4	125	2.5K	MSOP8
ABH001-00	5	40	0.5	4	15	150	1.2K	MSOP8

### Notes:

- Oersted (Oe) = 1 Gauss in air.
- Unipolar operation means exposure to magnetic fields of one polarity, for example 0 to +30 Gauss, or -2 to -50 Gauss. Bipolar operation (for example, -5 to +10 Gauss) will increase nonlinearity and hysteresis

## AA Sensors

### Features:

- Excellent Sensitivity to Applied Magnetic Fields
- Wheatstone Bridge Analog Output
- Operating Temperature to 125°C Continuous
- Wide Linear Range of Operation
- Near-Zero Voltage Operation
- DC to >1MHz Frequency Response
- Small, Low-Profile Surface Mount Packages

### Applications:

- General Motion, Speed, and Position Sensing
- Low Power, Low Voltage Applications
- Low Field Sensing for Magnetic Media Detection
- Current Sensing

### Description:

The basic AA-Series GMR sensors are general-purpose magnetometers for use in a wide variety of applications. They exhibit excellent linearity, a large output signal with applied magnetic fields, stable and linear temperature characteristics, and a purely ratiometric output.

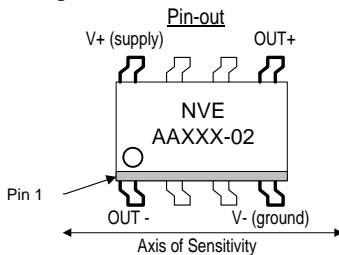

**Functional Block Diagram**

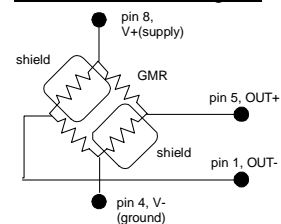

### Magnetic Characteristics:

Part Number	Saturation Field (Oe <sup>1</sup> )	Linear Range ((Oe <sup>1</sup> ))		Sensitivity (mV/V-Oe <sup>1</sup> )		Resistance (Ohms)	Package <sup>2</sup>	Die Size <sup>3</sup> (μm)
		Min	Max	Min	Max			
AA002-02	15	1.5	10.5	3.0	4.2	5K ±20%	SOIC8	436x3370
AA003-02	20	2.0	14	2	3.2	5K ±20%	SOIC8	436x3370
AA004-00	50	5	35	0.9	1.3	5K ±20%	MSOP8	411x1458
AA004-02	50	5	35	0.9	1.3	5K ±20%	SOIC8	411x1458
AA005-02	100	10	70	0.45	0.65	5K ±20%	SOIC8	411x1458
AA006-00	50	5	35	0.9	1.3	30K ±20%	MSOP8	836x1986
AA006-02	50	5	35	0.9	1.3	30K ±20%	SOIC8	836x1986

**General Characteristics:**

Parameter	Min	Typical	Max	Unit
Input Voltage Range	<1 <sup>4</sup>		24 <sup>4</sup>	Volts
Operating Frequency	DC		>1	MHz
Operating Temperature Range	-50		125	°C
Bridge Electrical Offset	-4		+4	mV/V
Signal Output at Max. Field		60		mV/V
Nonlinearity			2	% (unipolar) <sup>5</sup>
Hysteresis			4	% (unipolar) <sup>5</sup>
TCR		+0.14		% / °C <sup>6</sup>
TCOI		+0.03		% / °C <sup>6</sup>
TCOV		-0.1		% / °C <sup>6</sup>
Off Axis Characteristic		Cos β <sup>7</sup>		
ESD Tolerance		400		V pin-to-pin HBM

**Notes:**

1. 1 Oersted (Oe) = 1 Gauss in air.
2. See the Appendix for package dimensions and tolerances.
3. Sensors can be provided in die form by special request.
4. GMR AA-Series sensors are pure ratiometric devices meaning that they will operate properly at extremely low supply voltages. The output signal will be proportional to the supply voltage. Maximum voltage range is limited by the power dissipation in the package and the maximum operating temperature of the sensor.
5. Unipolar operation means exposure to magnetic fields of one polarity, e.g., 0 to 30 Gauss, or 2 to -50 Gauss, but not -20 to +30 Gauss (bipolar operation). Bipolar operation will increase nonlinearity and hysteresis.
6. TCR is resistance change with temperature with no applied field. TCOI is the output change with temperature using a constant current source to power the sensor. TCOV is the output change with temperature using a constant voltage source to power the sensor. See the graphs below.
7. Beta (β) is any angle deviation from the sensitive axis.

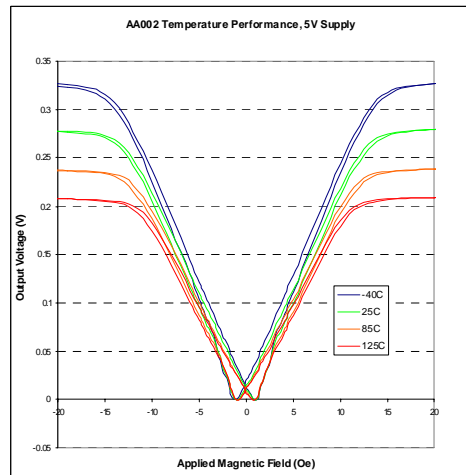
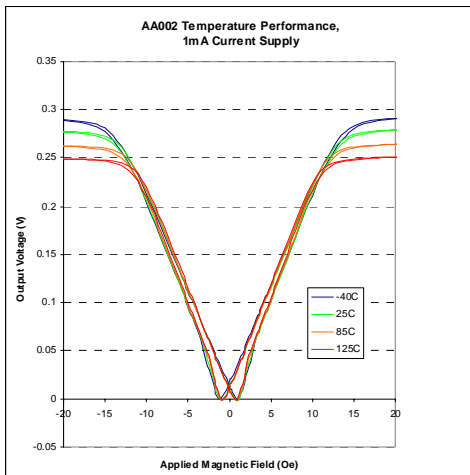

## AAH Sensors

### Features:

- Extremely High Sensitivity to Applied Magnetic Fields
- Wheatstone Bridge Analog Output
- Temperature Tolerance to 150°C Continuous
- Near-Zero Voltage Operation
- DC to >1MHz Frequency Response
- Small, Low-Profile Surface Mount Packages

### Applications:

- Low Voltage, High Temperature Applications
- Low Field Sensing for Magnetic Media Detection
- Earth's Magnetic Field Detection
- Current Sensing

### Description:

The AAH-Series GMR sensors are manufactured with a high sensitivity GMR material, making them ideally suited for any low magnetic field application. They are also extremely temperature tolerant, to +150°C operating temperatures.

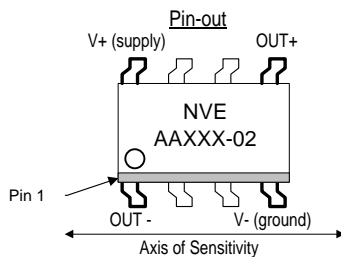

### Functional Block Diagram

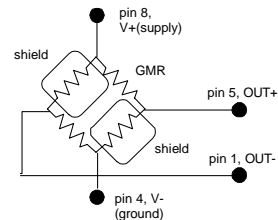

### Magnetic Characteristics:

Part Number	Saturation Field (Oe <sup>1</sup> )	Linear Range (Oe <sup>1</sup> )		Sensitivity (mV/V-Oe <sup>1</sup> )		Resistance (Ohms)	Package <sup>2</sup>	Die Size <sup>3</sup> (µm)
		Min	Max	Min	Max			
AAH002-02	6	0.6	3.0	11.0	18.0	2K ±20%	SOIC8	436x3370
AAH004-00	15	1.5	7.5	3.2	4.8	2K ±20%	MSOP	411x1458

**General Characteristics:**

Parameter	Min	Typical	Max	Unit
Input Voltage Range	<1 <sup>4</sup>		±12 <sup>7</sup>	Volts
Operating Frequency	DC		>1	MHz
Operating Temperature Range	-50		150	°C
Bridge Electrical Offset	-5		+5	mV/V
Signal Output at Max. Field		40		mV/V
Nonlinearity		4		% (unipolar) <sup>5</sup>
Hysteresis		15		% (unipolar) <sup>5</sup>
TCR		+0.11		% / °C <sup>6</sup>
TCOI		+0.10		% / °C <sup>6</sup>
TCOV		0.0		% / °C <sup>6</sup>
Off Axis Characteristic		Cos β <sup>7</sup>		
ESD Tolerance		400		V pin-to-pin HBM

**Notes:**

- 1 Oersted (Oe) = 1 Gauss in air.
- See the Appendix for package dimensions and tolerances.
- Sensors can be provided in die form by special request.
- GMR AAH-Series sensors are pure ratiometric devices meaning that they will operate properly at extremely low supply voltages. The output signal will be proportional to the supply voltage. Maximum voltage range is limited by the power dissipation in the package and the maximum operating temperature of the sensor.
- Unipolar operation means exposure to magnetic fields of one polarity, e.g. 0 to 30 Gauss, or -2 to -50 Gauss, but not -20 to +30 Gauss (bipolar operation). Bipolar operation will increase nonlinearity and hysteresis.
- TCR is resistance change with temperature with no applied field. TCOI is the output change with temperature using a constant current source to power the sensor. TCOV is the output change with temperature using a constant voltage source to power the sensor.
- Beta (β) is any angle deviation from the sensitive axis.

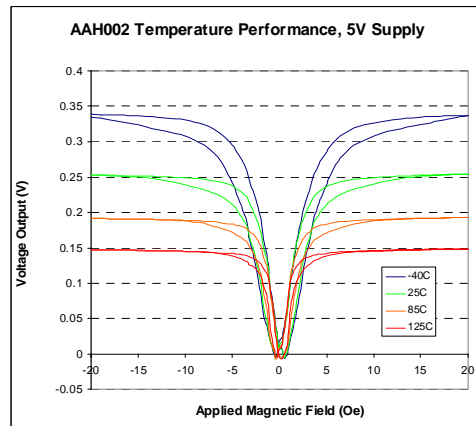
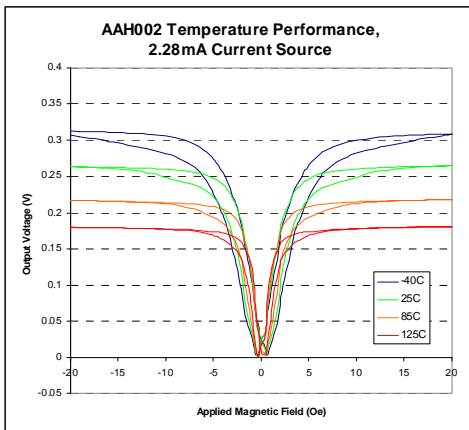

## AAL Sensors

### Features:

- Excellent Sensitivity to Applied Magnetic Fields
- Wheatstone Bridge Analog Output
- Temperature Tolerance to 150°C Continuous
- Very Low Magnetic Hysteresis
- Near-Zero Voltage Operation
- DC to >1MHz Frequency Response
- Small, Low-Profile Surface Mount Packages

### Applications:

- General Motion, Speed, and Position Sensing
- Low Voltage, High Temperature Applications
- Low Field Sensing for Magnetic Media Detection
- Current Sensing

### Description:

The AAL-Series GMR sensors are manufactured with a low hysteresis GMR material, for use in magnetometer applications where minimum hysteresis is important. They are also extremely temperature tolerant, to +150°C operating temperatures.

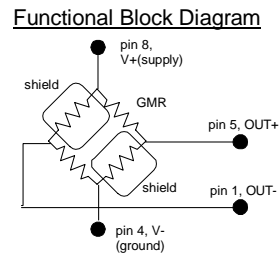
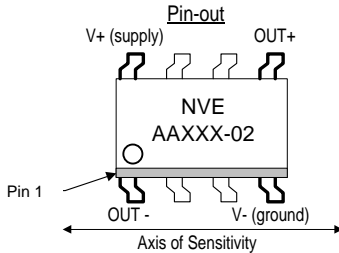

### Magnetic Characteristics:

Part Number	Saturation Field (Oe <sup>1</sup> )	Linear Range ( Oe <sup>1</sup>  )		Sensitivity (mV/V-Oe <sup>1</sup> )		Resistance (Ohms)	Package <sup>2</sup>	Die Size <sup>3</sup> (µm)
		Min	Max	Min	Max			
AAL002-02	15	1.5	10.5	3.0	4.2	5.5K ±20%	SOIC8	436x3370

**General Characteristics:**

Parameter	Min	Typical	Max	Unit
Input Voltage Range	<1 <sup>4</sup>		±25 <sup>7</sup>	Volts
Operating Frequency	DC		>1	MHz
Operating Temperature Range	-50		150	°C
Bridge Electrical Offset	-4		+4	mV/V
Signal Output at Max. Field		45		mV/V
Nonlinearity			2	% (unipolar) <sup>5</sup>
Hysteresis			4	% (unipolar) <sup>5</sup>
TCR		+0.11		% / °C <sup>6</sup>
TCOI		-0.28		% / °C <sup>6</sup>
TCOV		-0.40		% / °C <sup>6</sup>
Off Axis Characteristic		Cos β <sup>7</sup>		
ESD Tolerance		400		V pin-to-pin HBM

**Notes:**

1. 1 Oersted (Oe) = 1 Gauss in air.
2. See the Appendix for package dimensions and tolerances.
3. Sensors can be provided in die form by special request.
4. GMR AAL-Series sensors are pure ratiometric devices meaning that they will operate properly at extremely low supply voltages. The output signal will be proportional to the supply voltage. Maximum voltage range is limited by the power dissipation in the package and the maximum operating temperature of the sensor.
5. Unipolar operation means exposure to magnetic fields of one polarity, e.g. 0 to 30 Gauss, or -2 to -50 Gauss, but not -20 to +30 Gauss (bipolar operation). Bipolar operation will increase nonlinearity and hysteresis.
6. TCR is resistance change with temperature with no applied field. TCOI is the output change with temperature using a constant current source to power the sensor. TCOV is the output change with temperature using a constant voltage source to power the sensor.
7. Beta (β) is any deviation angle from the sensitive axis.

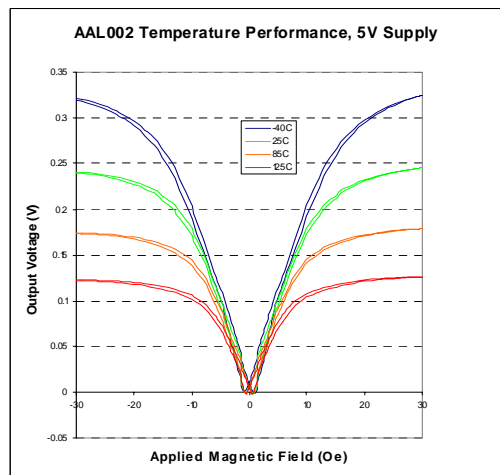
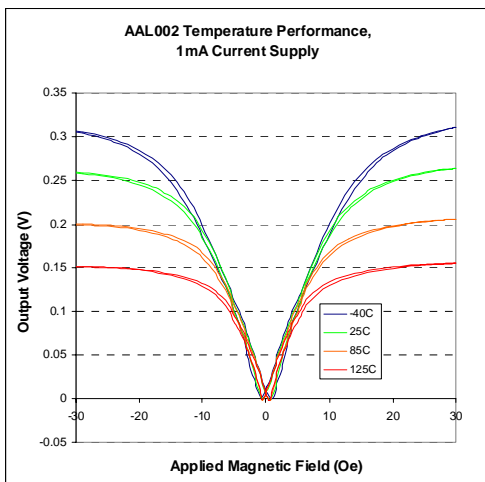



## AAV Sensors

### Features:

- Operates in Magnetic Saturation, 30 to 200 Gauss
- Half-Bridge or Individual Resistor Configurations
- Sine and Cosine Outputs Available
- Utilizes Spin Valve GMR Material
- Precise Detection of Magnetic Field
- Ultra-Small PLLP Package
- Cannot Be Damaged by Large External Magnetic Fields

### Description:

The AAV001-11 and AAV002-11 are arrays of four GMR resistors rotated at 90-degree intervals in the package. The AAV001-11 features independent resistors that can be wired together to form two half-bridges, or used as independent resistors. The AAV002-11 has the bridge connections made internally to the package. For either part, the output can be configured to represent the sine and cosine function of the magnetic field being applied to the sensor. Each resistor is 1.5 k $\Omega$  nominal resistance and output of each half-bridge is ratiometric with the power supply voltage. The part features NVE's PLLP6 housing, which is a 3.0 mm x 3.0 mm x 0.9 mm thick surface mount package.

### Operation:

The sensor elements contain two magnetic layers: a pinned, or fixed-direction layer, and a movable or free layer. The diagram below illustrates the configuration with arrows representing the two layers:

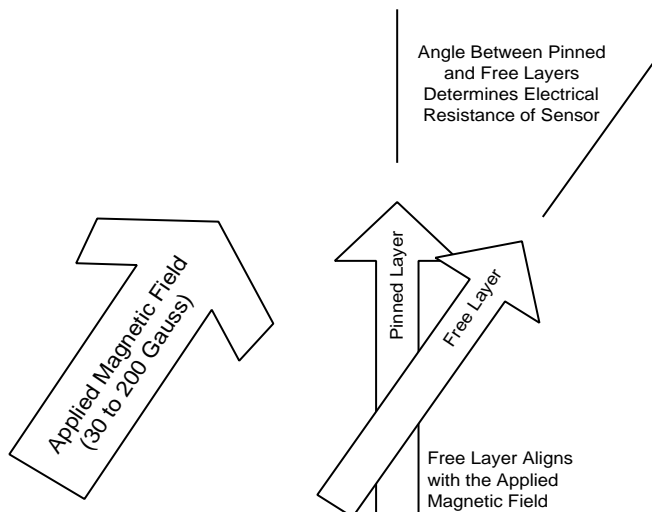

The end user must apply a saturating magnetic field (30 to 200 Oersteds) in the plane of the sensor in order for the sensor to operate. The movable layer will align with the applied magnetic field. As the applied field changes direction the angle between the movable layer and the pinned layer changes, resulting in a change of resistance in the device. A graph of the device resistance vs. the angle between the pinned layer and the movable layer is shown below:

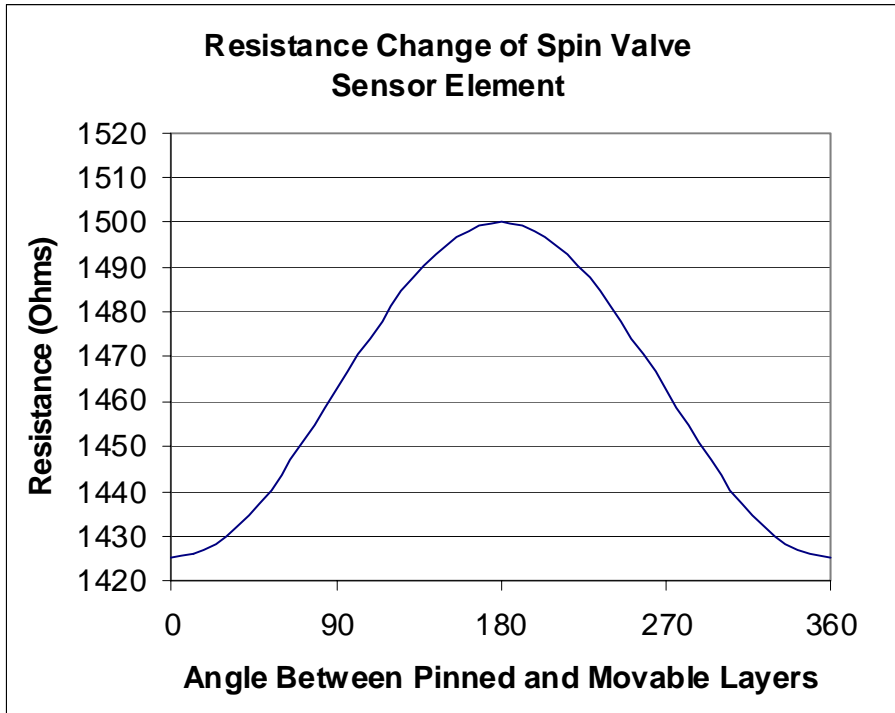

Four individual sensor resistors are supplied in the package, each with the pinned layer rotated 90° with respect to that of the previous sensor. These resistors can be connected in two half-bridge configurations to provide a sine and cosine output or monitored individually to provide an absolute indication of the angle between the pinned layer and the movable layer.

A drawing showing the ICs position in the package is given below. On each IC there is an arrow indicating the direction of the pinned layer.

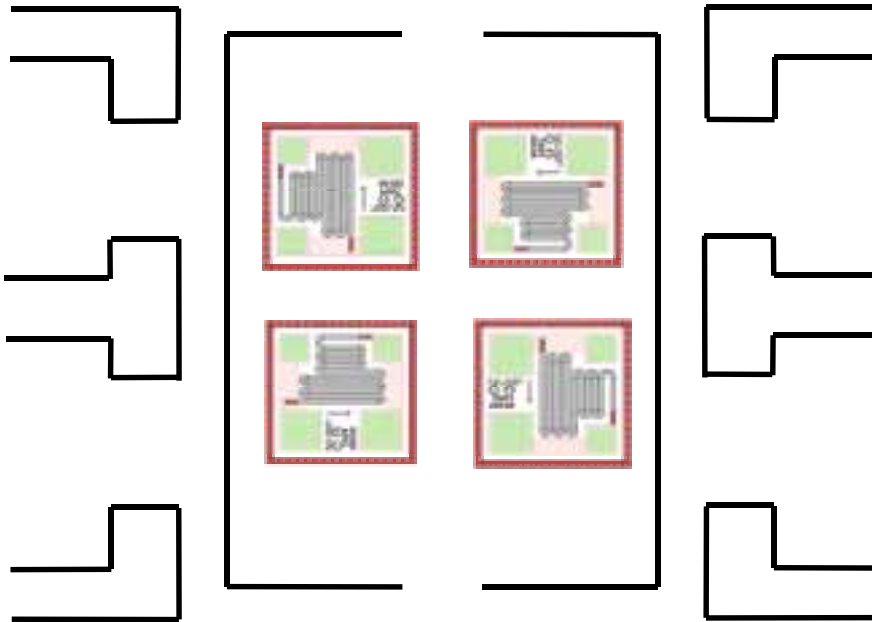

Functional Block Diagram, Marking, and Pinout, AAV001-11:

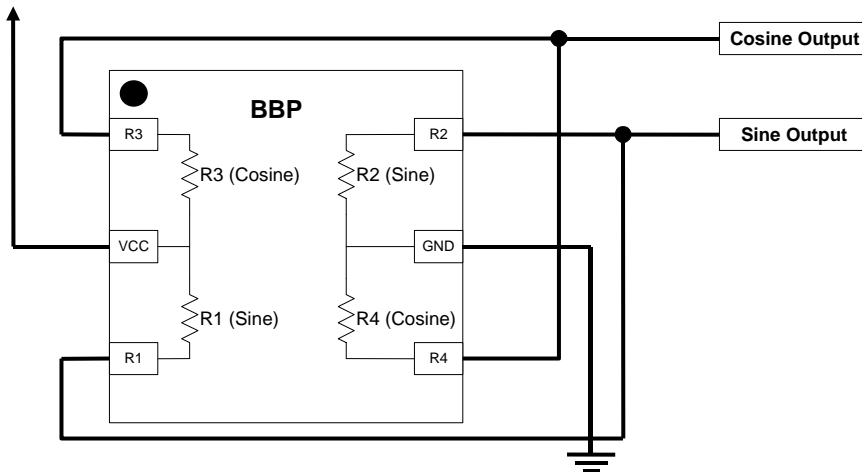

**Functional Block Diagram, Marking, and Pinout, AAV002-11:**

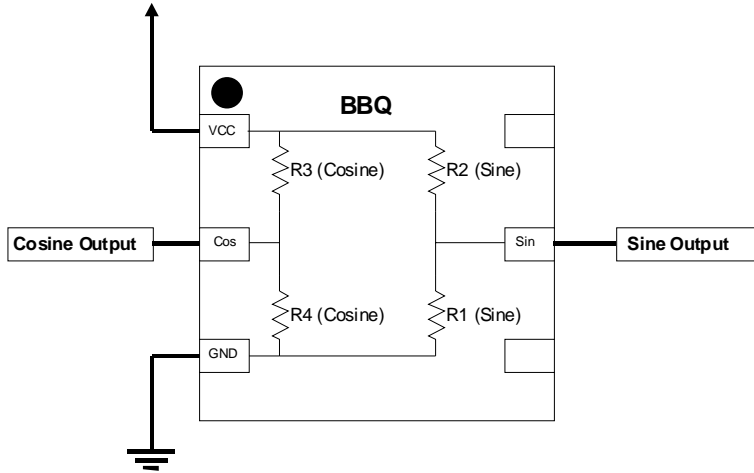

**Specifications:**

Parameter	Test Condition	Min	Typ	Max	Units
Nominal Resistance of Each Resistor	25°C	1200	1500	1800	Ohms
Maximum Resistance Decrease with Field Change	Operating at 25°C	4.5%	5.2%	7%	
Required Strength of Applied Magnetic Field	Operating	30		200	Oersted <sup>2</sup>
Measurement Error	Operating			2	Degrees
Supply Voltage	Operating			12	Volts
Offset Voltage	Operating at 25°C	-10		10	mV/V
Temperature Range of Operation	Operating	-40		150	°C
Storage Temperature		-40		170	°C
Temperature Coefficient of Resistance	Operating		+0.3		%/°C
TCOV <sup>3</sup>	Operating		-0.24		%/°C
TCOI <sup>3</sup>	Operating		-0.16		%/°C

**Notes:**

1. Large Magnetic Fields WILL NOT cause damage to NVE GMR Sensors.
2. 1 Oe (Oersted) = 1 Gauss in air = 0.1 mTesla = 79.8 Amps/meter.
3. TCOV is the percent change in output signal over temperature with a constant voltage source powering the part and TCOI is the percent change in output over temperature with a constant current source.

## AB Sensors

### Features:

- Excellent Sensitivity to Applied Magnetic Fields
- Wheatstone Bridge Analog Output
- Temperature Tolerance to 125°C Continuous
- Wide Linear Range of Operation
- Near-Zero Voltage Operation
- DC to >1MHz Frequency Response
- Small, Low-Profile Surface Mount Packages

### Applications:

- General Differential Field Sensing
- Gear Tooth and Encoder Speed and Position Sensing
- Low Power, Low Voltage Applications

### Description:

The AB-Series GMR sensors are general-purpose gradiometers for use in a wide variety of applications. Two pairs of unshielded GMR sensor elements provide for directional sensing of small gradients in large and small magnetic fields. The ability to detect only magnetic gradients allows low sensitivity to external sources of uniform magnetic field allowing these sensors to work successfully in high magnetic noise environments such as near electric motors or current carrying wires.

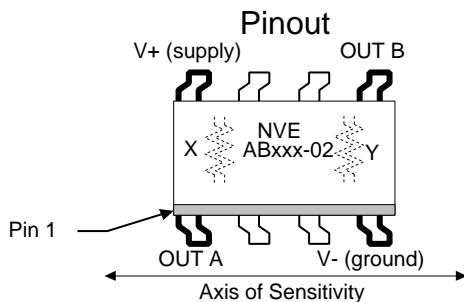

### Functional Block diagram

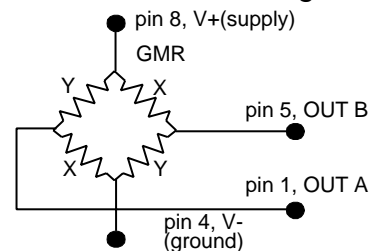

### Magnetic Characteristics:

Part Number	Saturation Field (Oe <sup>1</sup> )	Linear Range ( Oe <sup>1</sup>  )		Resistor Sensitivity (%R / Oe <sup>1</sup> )		Resistance (Ohms)	Package <sup>2</sup>	Die Size <sup>3</sup> (µm)
		Min	Max	Min	Max			
AB001-02	250	10	175	0.02	0.03	2.5K ±20%	SOIC8	651x1231
AB001-00	250	10	175	0.02	0.03	2.5K ±20%	MSOP8	651x1231

**General Characteristics:**

Parameter	Min	Typical	Max	Unit
Input Voltage Range	<1 <sup>4</sup>		±12.5 <sup>4</sup>	Volts
Operating Frequency	DC		>1	MHz
Operating Temperature Range	-50		125	°C
Bridge Electrical Offset	-4		+4	mV/V
Signal Output at Max. Field		120		mV/V
Nonlinearity			2	% (unipolar) <sup>5</sup>
Hysteresis			4	% (unipolar) <sup>5</sup>
TCR		+0.14		% / °C <sup>6</sup>
TCOI		+0.03		% / °C <sup>6</sup>
TCOV		-0.1		% / °C <sup>6</sup>
Off Axis Characteristic		Cos β <sup>7</sup>		
ESD Tolerance		400		V pin-to-pin HBM

**Notes:**

- 1 Oersted (Oe) = 1 Gauss in air.
- See the Appendix for package dimensions and tolerances.
- Sensors can be provided in die form by special request.
- GMR AB-Series sensors are pure ratiometric devices, meaning that they will operate properly at extremely low supply voltages. The output signal will be proportional to the supply voltage. Maximum voltage range is limited by the power dissipation in the package and the maximum operating temperature of the sensor.
- Unipolar operation means exposure to magnetic fields of one polarity, e.g., 0 to 30 Gauss, or -2 to -50 Gauss, but not -20 to +30 Gauss (bipolar operation). Bipolar operation will increase nonlinearity and hysteresis.
- TCR is resistance change with temperature with no applied field. TCOI is the output change with temperature using a constant current source to power the sensor. TCOV is the output change with temperature using a constant voltage source to power the sensor.
- Beta (β) is any angle deviation from the sensitive axis.

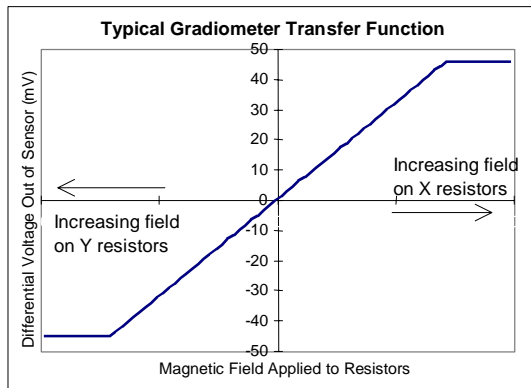

The Figure at left is a simulated output from an NVE Gradiometer. The output / gradient correlation shown assumes one pair of resistors is held at zero field. Note the bipolar output.

## ABH Sensors

### Features:

- Extremely High Sensitivity to Applied Magnetic Fields
- Wheatstone Bridge Analog Output
- Temperature Tolerance to 150°C Continuous
- Wide Linear Range of Operation
- Near-Zero Voltage Operation
- DC to >1MHz Frequency Response
- Small, Low-Profile Surface Mount Packages

### Applications:

- General Differential Field Sensing
- Gear Tooth and Encoder Speed and Position Sensing
- Low Voltage, High Temperature Applications

### Description:

The ABH-Series GMR sensors are low field, high temperature gradiometers for use in a wide variety of applications. Two pairs of unshielded GMR sensor elements provide for directional sensing of small gradients in large and small magnetic fields. The ability to detect only magnetic gradients allows low sensitivity to external sources of uniform magnetic field allowing these sensors to work successfully in high magnetic noise environments such as near electric motors or current carrying wires.

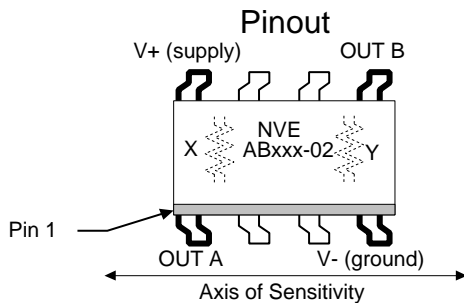

### Functional Block diagram

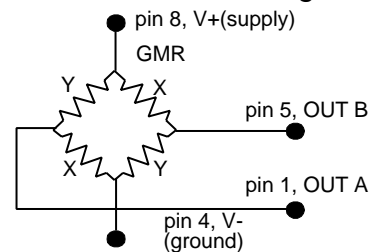

### Magnetic Characteristics:

Part Number	Saturation Field (Oe) <sup>1</sup>	Linear Range (Oe) <sup>1</sup>		Resistor Sensitivity (%R / Oe) <sup>1</sup>		Resistance (Ohms)	Package <sup>2</sup>	Die Size <sup>3</sup> (µm)
		Min	Max	Min	Max			
ABH001-00	70	5	40	0.06	0.12	1.2K ±20%	MSOP8	651x1231

## General Characteristics:

Parameter	Min	Typical	Max	Unit
Input Voltage Range	<1 <sup>4</sup>		±6 <sup>4</sup>	Volts
Operating Frequency	DC		>1	MHz
Operating Temperature Range	-50		150	°C
Bridge Electrical Offset	-4		+4	mV/V
Signal Output at Max. Field		80		mV/V
Nonlinearity			4	% (unipolar) <sup>5</sup>
Hysteresis			15	% (unipolar) <sup>5</sup>
TCR		+0.11		% / °C <sup>6</sup>
TCOI		+0.10		% / °C <sup>6</sup>
TCOV		0.0		% / °C <sup>6</sup>
Off Axis Characteristic		Cos β <sup>7</sup>		
ESD Tolerance		400		V pin-to-pin HBM

### Notes:

- 1 Oersted (Oe) = 1 Gauss in air.
- See the Appendix for package dimensions and tolerances.
- Sensors can be provided in die form by special request.
- GMR AB-Series sensors are pure ratiometric devices meaning that they will operate properly at extremely low supply voltages. The output signal will be proportional to the supply voltage. Maximum voltage range is limited by the power dissipation in the package and the maximum operating temperature of the sensor.
- Unipolar operation means exposure to magnetic fields of one polarity, e.g., 0 to 30 Gauss, or -2 to -50 Gauss, but not -20 to +30 Gauss (bipolar operation). Bipolar operation will increase nonlinearity and hysteresis.
- TCR is resistance change with temperature with no applied field. TCOI is the output change with temperature, using a constant current source to run the sensor. TCOV is the output change with temperature, using a constant voltage source to run the sensor.
- Beta (β) is any angle deviation from the sensitive axis.

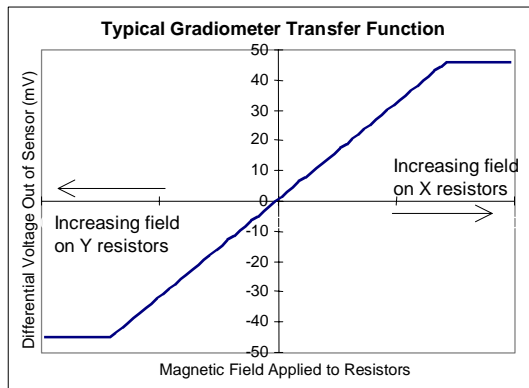

The Figure at left is a simulated output from an NVE Gradiometer. The output / gradient correlation shown assumes one pair of resistors is held at zero field. Note the bipolar output.